



# USE & CARE INSTRUCTIONS

## Guardian Technologies **Rechargeable 2-in-1 Stick Vac** with Silver Clean Technology

**English**      E - 1  
**French**        F - 1  
**Spanish**      S - 1

**Model No. GGS50**

1-Year Limited Warranty  
[www.guardiantechnologies.com](http://www.guardiantechnologies.com)  
1.866.603.5900  
**REV0409**

**Date Purchased**

month \_\_\_\_\_  
year      \_\_\_\_\_

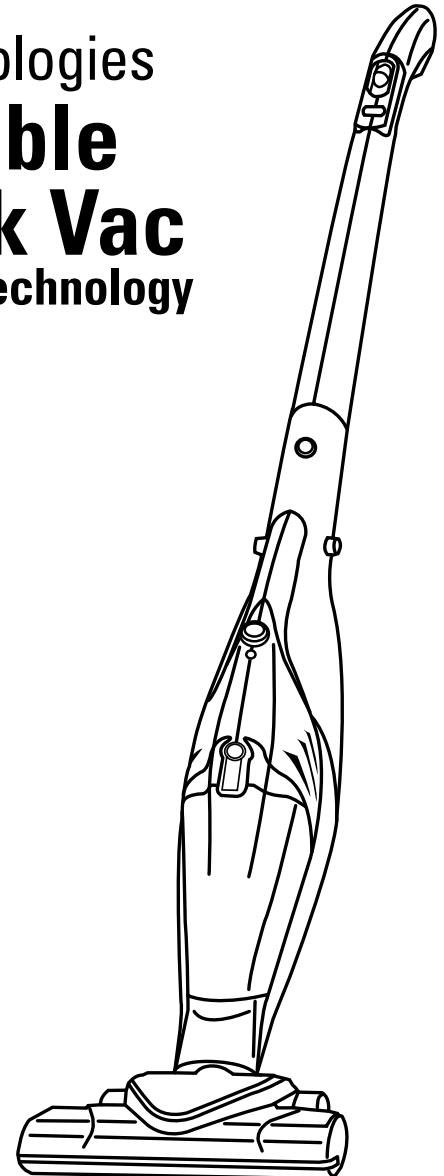

THIS VACUUM IS INTENDED FOR HOUSEHOLD USE ONLY  
**IMPORTANT SAFETY INSTRUCTIONS**  
**SAVE THESE INSTRUCTIONS.**

When using an electrical appliance, basic precautions should always be followed, including the following:

**WARNING: THE CORDS, WIRES AND/OR CABLES SUPPLIED WITH THIS PRODUCT CONTAIN CHEMICALS, INCLUDING LEAD OR LEAD COMPOUNDS, KNOWN TO THE STATE OF CALIFORNIA TO CAUSE CANCER AND BIRTH DEFECTS OR OTHER REPRODUCTIVE HARM. WASH HANDS AFTER USING.**

**READ ALL INSTRUCTIONS BEFORE USING THIS APPLIANCE.**

1. **SAVE THESE INSTRUCTIONS** - This manual contains important safety and operating instructions for the GGS50 Rechargeable 2-in-1 Stick Vac.
2. Before using battery charger, read all instructions and cautionary markings on the battery charger, battery and vacuum.
3. To reduce the risk of battery explosion, follow these instructions and those marked on the battery.
4. **Caution** - To reduce the risk of injury, use battery charger only with vacuum/battery provided. Other types of products/batteries may burst causing personal injury and damage.
5. **WARNING** - To reduce the risk of electric shock, do not use outdoors or on wet surfaces. Do not expose to rain. Store indoors. Do not use nozzle on wet surfaces.
6. Do not allow to be used as a toy. Close attention is necessary when used by or near children.
7. Use only as described in this manual. Use only manufacturer's recommended attachments.
8. Do not use with damaged cord or plug. If appliance is not working as it should, has been dropped, damaged, left outdoors or dropped into water, return it to a service center.
9. Do not put any objects into openings. Do not use with any opening blocked; keep free of dust, lint, hair and anything that may reduce air flow.
10. Keep hair, loose clothing, fingers and all parts of body away from openings and moving parts.
11. Turn off all controls before unplugging.
12. Use extra care when cleaning on stairs.
13. Do not use to pick up flammable or combustible liquids, such as gasoline or use in areas where they may be present.
14. Do not pull or carry by cord, use cord as a handle, close a door on cord or pull cord around sharp edges or corners. Keep cord away from heater surfaces.
15. Do not unplug by pulling on cord. To unplug, grasp the plug, not the cord.
16. Do not handle plug or appliance with wet hands.
17. Use only the charger supplied by the manufacturer to recharge.
18. Do not pick up anything that is burning or smoking, such as cigarettes, matches or hot ashes.
19. Do not use without dust filter in place.
20. Do not incinerate this appliance even if it is severely damaged. The batteries can explode in a fire.

**NOTE:** This product is shipped with the handle of the stick vacuum unassembled from the body of the stick vacuum for packing purposes. Upon unpacking and assembly - **DO NOT** disassemble product.

PLEASE READ ALL INSTRUCTIONS BEFORE USING THIS APPLIANCE

**SPECIFICATIONS**

Model Number ..... GGS50  
 DC Power ..... 9.6V  
 Motor Amp ..... 8.1 amps  
 Motor Wattage ..... 75 watts

Dirt Cup Capacity ..... 0.42 quarts  
 Dimensions ... 9.75"W x 45"H x 5.75"D  
 Weight ..... 4.8 pounds

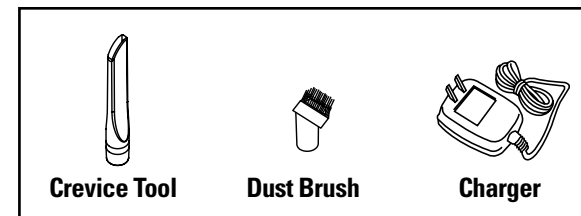
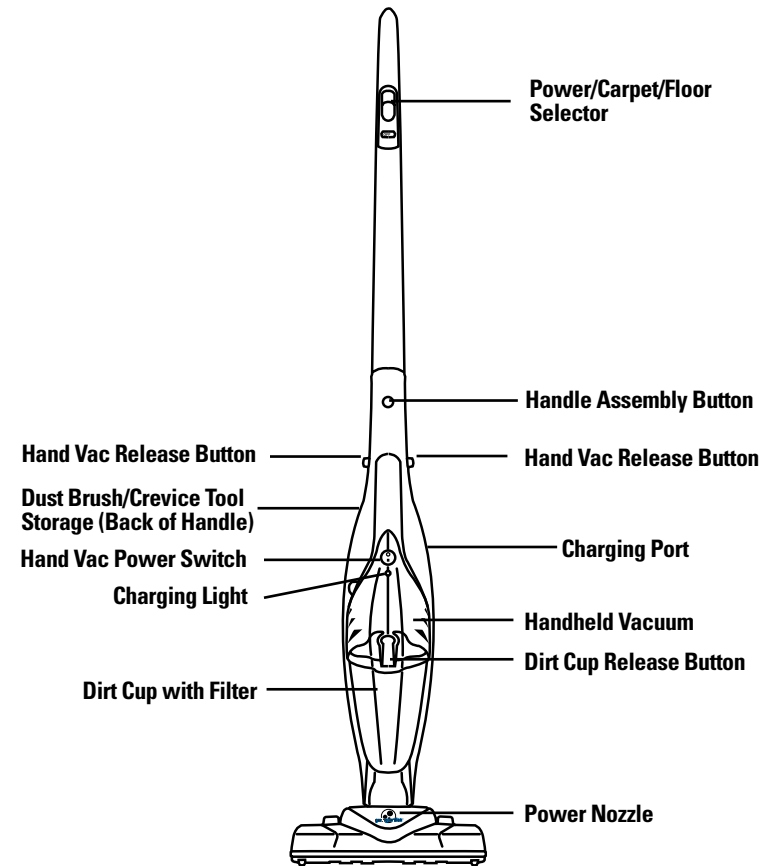

## ASSEMBLY

1. Press handle assembly button while inserting the handle into the handle opening on the main body making sure not to pinch internal cord. Handle assembly button will snap into place when handle is fully connected. (Fig. 1)
2. Attach the power nozzle into the air intake of the main body making sure contacts between the nozzle and body are aligned and inserted completely. (Fig. 2)

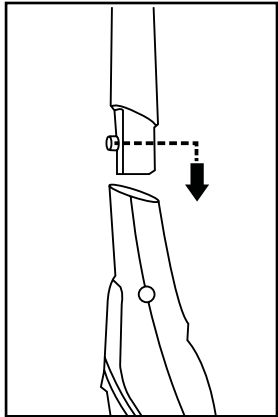

Fig. 1

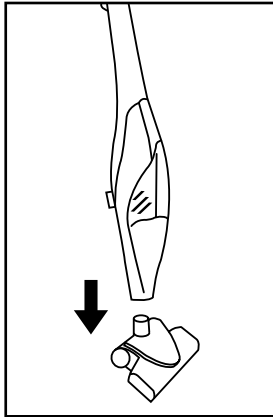

Fig. 2

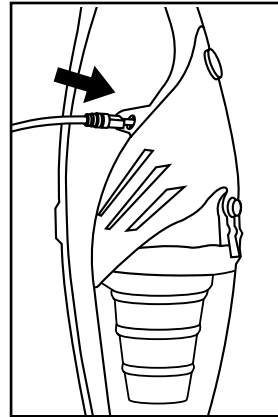

Fig. 3

## CHARGING

**NOTE:** Use only the charger supplied by the manufacturer to recharge.

**IMPORTANT:** Before first use, charge your vacuum for at least 24 hours.

Both power switches must be in the OFF position when unit is charging on base. If charging light is not illuminated, press ON/OFF button to assure unit is turned off. Remember, unit will not charge if charging light is not illuminated.

**CAUTION:** Do not allow the battery to run down completely before charging. Running down battery will cause battery life to shorten severely.

1. Connect charger into the charging port located on the side of the vacuum (in the hand vac). (Fig. 3) Charge unit with hand vac stored on-board.
2. Connect wall charger to the outlet.
3. A red charging light will illuminate when unit is charging. Unit will be charged in 16-24 hours. Recharge unit as soon as the motor power decreases noticeably. The unit can be on a constant charge so it is always ready for use.
4. The light stays on and remains the same color even when the unit is fully charged.

## DIRECTIONS FOR USE

### STICK VAC

**NOTE:** Be sure hand vac is properly stored on-board before using stick vac.

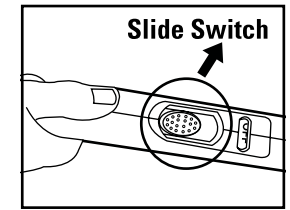

Fig. 4

1. Slide the Selector switch to either FLOOR (suction only/brushroll off) or CARPET (suction with brushroll on). (Fig. 4)
2. Use complete stick vac to remove dust and debris from bare floors and carpets.
3. Tools can be inserted at bottom of stick vac by removing nozzle base and inserting tool into opening. Ideal for hard-to-reach, above floor cleaning.

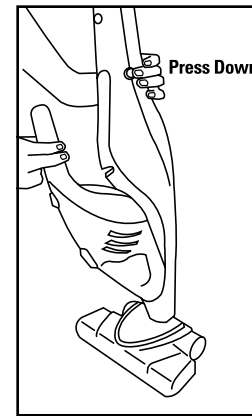

Fig. 5

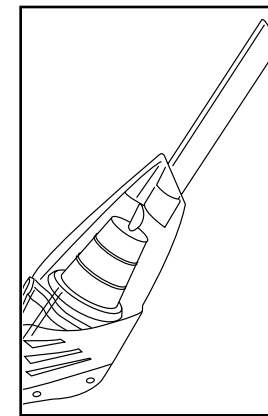

Fig. 6

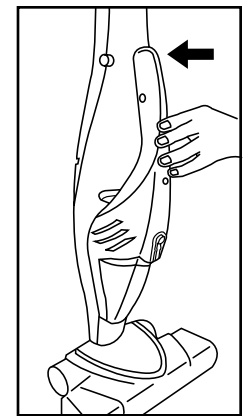

Fig. 7

### HAND VAC

1. Press two side HAND VAC RELEASE buttons and pull the hand vac from the main unit. (Fig. 5)
2. Turn power switch ON.
3. Use for above floor cleaning such as counters, upholstery etc.
4. Insert crevice tool/dust brush into the opening of nozzle to extend reach. (Fig. 6)
5. To replace the handheld unit, insert the dirt cup into the main body first then press the upper portion of the hand vac into the main body until it's secure. (Fig. 7)
6. Empty and clean dirt cup and filter after each use or when cup is full.

## DIRT CUP & FILTER: CLEANING AND REPLACEMENT

**IMPORTANT:** For best results empty dirt cup and clean the filter after each use.

### CLEANING

1. Press dirt cup release and separate dirt cup to remove. (Fig. 8)
2. Grasp filter and pull to remove from cup. (Fig. 9)
3. Tap to remove dirt or debris from filter.
4. Empty dirt cup contents into trash bin.
5. Return filter by aligning with dirt cup.
6. Align and re-attach dirt cup/nozzle.
7. Return hand vac to main stick vac body for storage and charging.

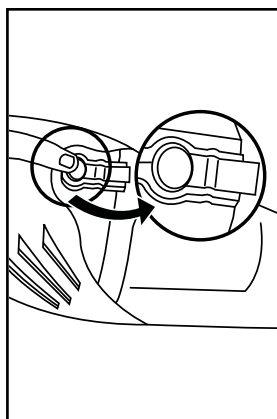

Fig. 8

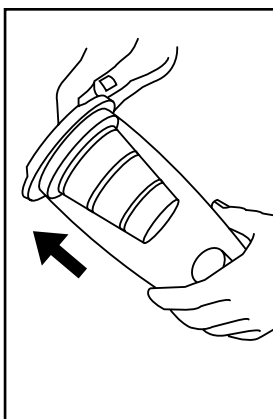

Fig. 9



Fig. 10

### FILTER REPLACEMENT

**NOTE:** For best performance, replace filter every 6 months.

1. Remove filter as described in CLEANING INSTRUCTIONS.
2. Twist the filter to separate it from the filter adapter. (Fig. 10)
3. Keep the filter adapter and discard of old filter.
4. Reattach filter adapter and new filter. Twist to secure.
5. Return filter assembly to dirt cup.

### NOTE

Replacement parts can be purchased by calling **1.866.603.5900**  
or by visiting [www.guardiantechnologies.com](http://www.guardiantechnologies.com)  
Replacement Filter Model No. FLT

## POWER BRUSH

**IMPORTANT:** Disconnect cleaner from electrical outlet.

1. To maintain cleaning effectiveness, regularly remove hair, lint, strings, threads etc. from the brushroll.
2. To remove brushroll for further cleaning turn tab on base of unit and remove small cover. (Fig. 11) Remove brushroll and endcaps. (Fig. 12) Reverse process to return to unit.

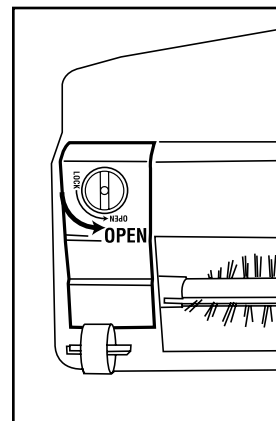

Fig. 11

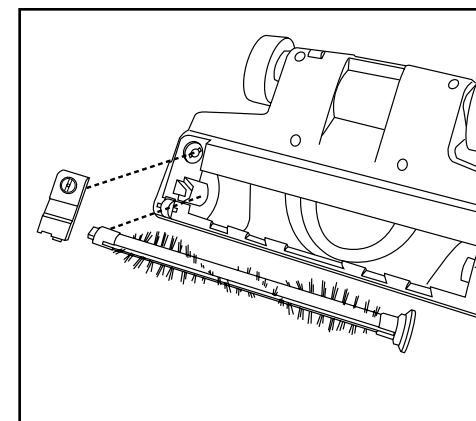

Fig. 12

## BATTERY DISPOSAL

To preserve natural resources, please recycle or dispose of expired battery pack properly. This product contains nickel-cadmium battery and must be disposed of properly. Local, state or federal laws may prohibit disposal of nickel-cadmium batteries in ordinary trash. Consult your local waste authority for information regarding available recycling and/or disposal options. For disposal information, call the rechargeable battery recycling corporation at **1-800-8BATTERY**.

## WARNING

Upon removal, cover the battery packs terminals with heavy duty adhesive tape. Do not attempt to destroy or disassemble battery pack or remove any of its components. Nickel-cadmium batteries must be recycled or disposed of properly. Also, never touch both terminals with metal objects and/or body parts as short circuit may result. Keep away from children. Failure to comply with these warnings could result in fire and/or serious injury.

# TROUBLESHOOTING GUIDE

PROBLEM	SOLUTION
Battery not charged.	Charge battery. Charge for atleast 24 hours before first use. Make sure power switch is OFF before charging.
Contacts between unit and base are dirty.	Clean contacts with cloth.
Battery dead - won't hold a charge.	Contact customer service. <b>Call 1.866.603.5900.</b>
Needs service.	Contact customer service. <b>Call 1.866.603.5900.</b>
Red indicator not lit.	Make sure adapter plug and socket are plugged in properly. Make sure both the handheld unit and the stick are turned to OFF while charging.
<b>Low or no suction</b> 1. Battery charge is getting weak. 2. Dirt cup is full. 3. Filter is dirty.	1. Charge battery. 2. Empty dirt cup. 3. Clean or replace filter.
<b>Dust escaping from vacuum</b> 1. Dirt cup is full. 2. Filter is dirty. 3. Hand vac is not in place.	1. Empty dirt cup. 2. Clean or replace filter. 3. Store hand vac on-board main body.
<b>Battery won't charge</b> Power button is in the ON position.	Turn power button OFF
Power nozzle brush not rotating.	Make sure switch on the handle is in the CARPET position. Remove dirt, debris, hair from brushroll.
Handheld unit works but stick does not.	Remove and return handheld to proper position making sure the 3 prongs/contacts are clean and free of debris. Contact customer service. <b>Call 1.866.603.5900.</b>
Machine does not stop when turned off.	Turn power button on both stick and hand vac to OFF.

## ANY OTHER SERVICING SHOULD BE DONE BY AN AUTHORIZED SERVICE REPRESENTATIVE/CUSTOMER SERVICE 1.866.603.5900.

In the event that further assistance is required, visit our website at [www.guardiantechnologies.com](http://www.guardiantechnologies.com). Costs of any transportation to and from any place of repair are to be paid by the owner. Always identify your product by the model number and manufacturing code when requesting information or ordering replacement parts.

# LIMITED WARRANTY

To the consumer, Guardian Technologies LLC warrants this product to be free of defects in materials and workmanship commencing upon the date of the original purchase. Save your original sales receipt to validate start of warranty period.

If this product should become defective within the warranty period, we will repair or replace any defective parts free of charge. The complete machine must be delivered pre-paid to any authorized Guardian Technologies LLC warranty service center. Please include complete information on the problem, date of purchase, copy of original sales receipt and your name, address and telephone number. If you are not near a warranty station, call the factory for assistance in the US and Canada at **1.866.603.5900**. Use only genuine Guardian Technologies replacement parts.

The warranty does not include unusual wear, damage resulting from accident or unreasonable use of the product. This warranty does NOT cover bulbs. This warranty does NOT cover unauthorized repairs. This warranty gives you specific legal rights and you may have other rights (other rights may vary from state to state in the U.S.A).

We consider the registration process important to ensuring superior service to our customers, however submitting this card to Guardian Technologies LLC is optional and does not affect your right to utilize this warranty according to the conditions above. If you have any questions or comments about our product call Toll Free at **1.866.603.5900** or send comments to:

**ATTN Customer Service  
Guardian Technologies LLC  
7700 St. Clair Avenue  
Mentor, Ohio 44060**

## Guardian Technologies LLC

7700 St Clair Avenue | Mentor Ohio 44060  
1.866.603.5900 | [www.guardiantechnologies.com](http://www.guardiantechnologies.com)